

FACE MOULDING BITS

Face moulding bits can be used for window sills, architraves, picture frames or handrails.

FACE MOULDING BIT

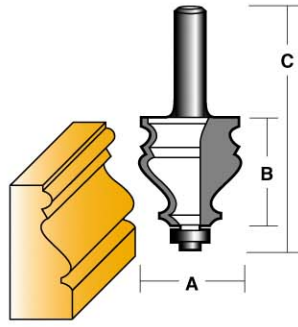

CARBIDE TIPPED - TWO FLUTES WITH BALL BEARING GUIDE
12.7mm (1/2") SHANK

PART No.	A		B		C	
	in.	mm	in.	mm	in.	mm
TFM 36 B 1/2	1-1/2	38.1	1-5/8	41.3	3-5/8	92

Replacement Ball Bearing TB8.

FACE MOULDING BIT

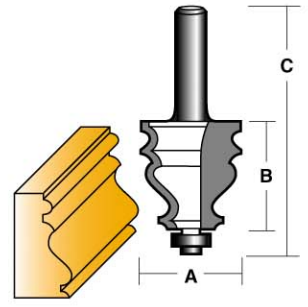

CARBIDE TIPPED - TWO FLUTES WITH BALL BEARING GUIDE
12.7mm (1/2") SHANK

PART No.	A		B		C	
	in.	mm	in.	mm	in.	mm
TFM 42 B 1/2	1-1/2	38.1	1-5/8	41.3	3-5/8	92

Replacement Ball Bearing TB8.

FACE MOULDING BIT

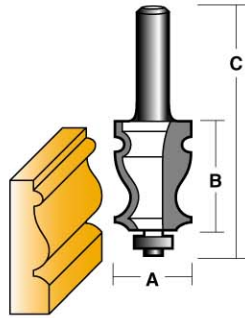

CARBIDE TIPPED - TWO FLUTES WITH BALL BEARING GUIDE
12.7mm (1/2") SHANK

PART No.	A		B		C	
	in.	mm	in.	mm	in.	mm
TFM 48 B 1/2	1-1/8	28.6	1-5/8	41.3	3-13/16	96.5

Replacement Ball Bearing TB8.

FACE MOULDING BIT

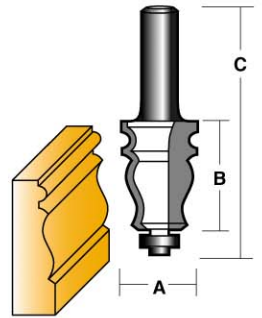

CARBIDE TIPPED - TWO FLUTES WITH BALL BEARING GUIDE
12.7mm (1/2") SHANK

PART No.	A		B		C	
	in.	mm	in.	mm	in.	mm
TFM 54 B 1/2	1-1/8	28.6	1-5/8	41.3	3-5/8	92

Replacement Ball Bearing TB8.

FACE MOULDING BIT

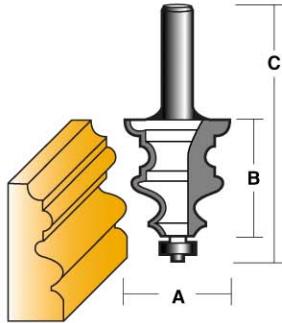

CARBIDE TIPPED - TWO FLUTES WITH BALL BEARING GUIDE
12.7mm (1/2") SHANK

PART No.	A		B		C	
	in.	mm	in.	mm	in.	mm
TFM 60 B 1/2	1-5/8	41.3	1-3/4	44.5	3-7/8	98

Replacement Ball Bearing TB8.

FACE MOULDING BIT

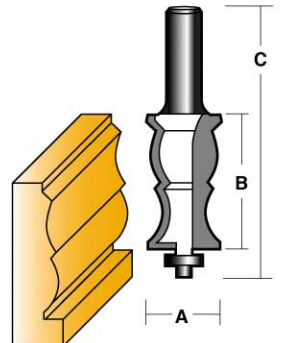

CARBIDE TIPPED - TWO FLUTES WITH BALL BEARING GUIDE
12.7mm (1/2") SHANK

PART No.	A		B		C	
	in.	mm	in.	mm	in.	mm
TFM 66 B 1/2	1-1/8	28.6	2-1/4	57.1	4-3/8	111.5

Replacement Ball Bearing TB8.

FACE MOULDING BIT

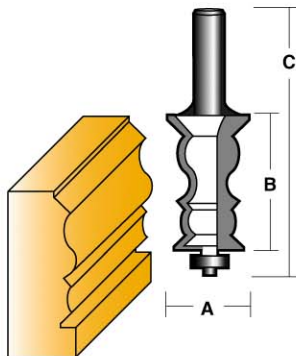

CARBIDE TIPPED - TWO FLUTES WITH BALL BEARING GUIDE
12.7mm (1/2") SHANK

PART No.	A		B		C	
	in.	mm	in.	mm	in.	mm
TFM 72 B 1/2	1-1/8	28.6	2-1/4	57.1	4-3/8	111.5

Replacement Ball Bearing TB8.

FACE MOULDING BIT

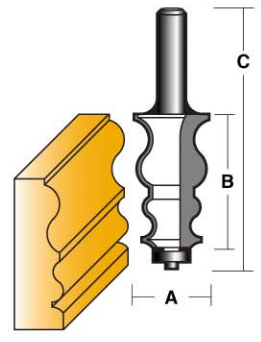

CARBIDE TIPPED - TWO FLUTES WITH BALL BEARING GUIDE
12.7mm (1/2") SHANK

PART No.	A		B		C	
	in.	mm	in.	mm	in.	mm
TFM 80 B 1/2	1-1/4	31.8	2-1/4	57.1	4-3/8	111.5

Replacement Ball Bearing TB8.

