

# GROOVE FORMING BITS

## HOOK SLOT BITS

This bit will quickly drill and slot a convenient screw, nail or hook slot in the back of a picture frame, hanging shield, etc.

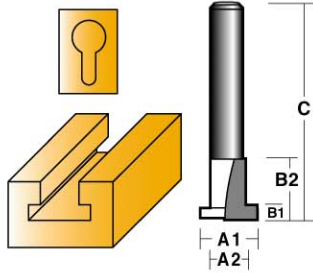

CARBIDE TIPPED - SINGLE FLUTE  
SUFFIX 1/2 = 1/2" SHANK, OTHERWISE 1/4"

PART No.	A1		A2		B1		B2		C	
	in.	mm	in.	mm	in.	mm	in.	mm	in.	mm
THS 12	.355	9	3/16	4.8	1/8	3.2	3/8	9.5	1-5/8	41
THS 16	1/2	12.7	5/16	8	1/8	3.2	1/2	12.7	1-3/4	44.4
THS 16 1/2	1/2	12.7	5/16	8	1/8	3.2	1/2	12.7	2-5/8	67

## T-SLOT CUTTERS

These bits allow you to make horizontal T-slots when used in hanging brackets, or creating wall display units, slatwall, etc.

**NEW**

CARBIDE TIPPED  
A1 - TWO FLUTES  
A2 - SINGLE FLUTE  
**12.7mm (1/2") SHANK**

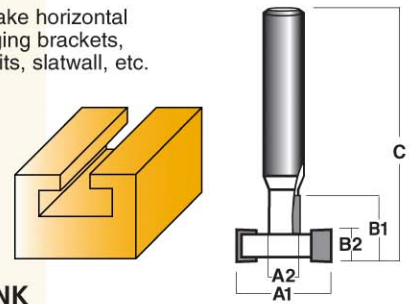

PART No.	A1		A2		B1		B2		C	
	in.	mm	in.	mm	in.	mm	in.	mm	in.	mm
TSA 28 1/2	1-7/64	28	25/64	10	57/64	22.7	25/64	10	3-3/32	78.5
TSA 30 1/2	1-3/16	30	25/64	10	57/64	22.7	25/64	10	3-3/32	78.5
TSA 30.6 1/2	1-13/64	30.6	27/64	10.6	45/64	18	25/64	10	3-3/32	78.5

# EDGE & FACE FORMING BITS

## "V" GROOVE BITS

### 22.5° VEE GROOVE BITS

22.5 Degree included Angle - Single Flute - Solid Carbide

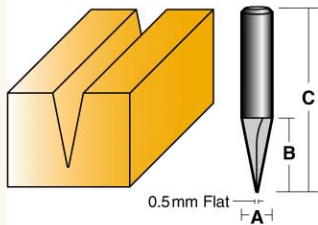

PART No.	A		B		C	
	in.	mm	in.	mm	in.	mm
TV 2208	1/4	6.4	37/64	14.7	2-1/4	57.2
TV 2216 1/2	1/2	12.7	1-13/64	30.6	3	76.2

### 30° VEE GROOVE BITS

30 Degree included Angle - Single Flute - Solid Carbide

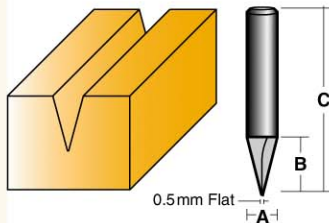

PART No.	A		B		C	
	in.	mm	in.	mm	in.	mm
TV 3008	1/4	6.4	-	10.9	2-1/4	57.2
TV 3016 1/2	1/2	12.7	-	22.8	3	76.2

### 60° VEE GROOVE BITS

This bit is specifically designed for sign and lettering work.

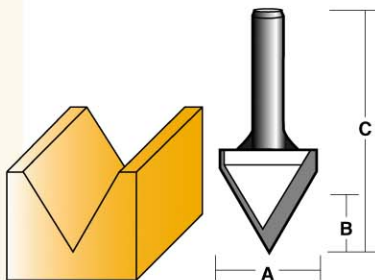

60° INCLUDED ANGLE  
CARBIDE TIPPED  
- TWO FLUTES

SUFFIX 1/2 = 1/2" SHANK, OTHERWISE 1/4"

\* These bits are not guaranteed against tip breakage due to thin section of carbide at the point

PART No.	A		B		C	
	in.	mm	in.	mm	in.	mm
T 6128	1	25.4	-	22.4	2-1/4	57.1
T 6128 1/2	1	25.4	-	22.4	2-3/4	70

### 90° VEE GROOVE BITS

A versatile bit for decorative vee grooves and chamfering. Used for sign and lettering work. Also mitre joints for box fabrication.

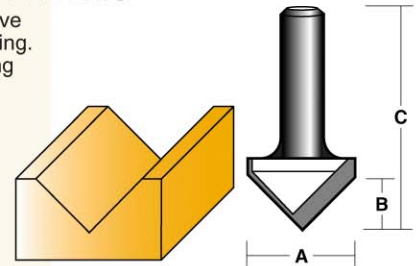

90° INCLUDED ANGLE  
TWO FLUTES  
CARBIDE TIPPED

SUFFIX 1/2 = 1/2" SHANK, OTHERWISE 1/4"

PART No.	A		B		C	
	in.	mm	in.	mm	in.	mm

HIGH SPEED STEEL

H 112	17/32	13.5	3/8	9.5	1-3/8	35
H 128	1-15/64	31.3	7/8	22	1-7/8	47

CARBIDE TIPPED

T 112	45/64	18	.365	9.2	1-3/4	44.4
T 128	1-15/64	31.3	5/8	15.9	2	50.8
T 128 1/2	1-15/64	31.3	5/8	15.9	2-1/2	63.5
T 1230 1/2	1-9/16	39.7	25/32	20	3-3/8	86
T 1240 1/2	2	50.8	1	25.4	3	76

### 120° VEE GROOVE BITS

120 Degree Included Angle - Two Flute - Carbide Tipped

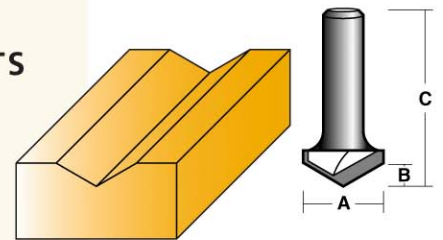

PART No.	A		B		C	
	in.	mm	in.	mm	in.	mm
TV 1232	1	25.4	-	7.5	1-45/64	43.3
TV 1232 1/2	1	25.4	-	7.5	2-13/64	55.9
TV 1264 1/2	2	50.8	-	14.7	2-29/32	73.8

