

LAMINATE TRIM BITS & CUTTERS

COMBINATION FLUSH TRIMMING & DRILLING BIT

Drills through surface laminate into pre-cut opening and trims edge square in one operation.

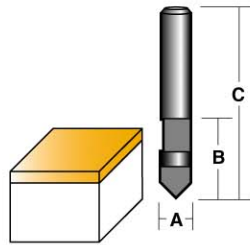

SOLID CARBIDE - SINGLE FLUTE WITH PILOT
6.35 mm (1/4") SHANK

PART No.	A		B		C	
	in.	mm	in.	mm	in.	mm
T 703-507	1/4	6.35	5/8	16	1-1/2	38.1

7° BEVEL TRIMMING BIT

Provides 7° bevel to trim the edge of plastic laminated surfaces. Built-in pilot eliminates guide assembly.

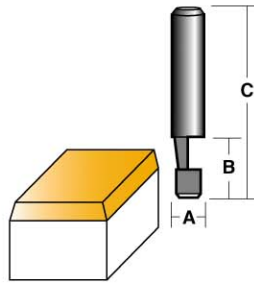

SOLID CARBIDE - SINGLE FLUTE WITH PILOT
6.35 mm (1/4") SHANK

PART No.	A		B		C	
	in.	mm	in.	mm	in.	mm
T 403-501	3/16	4.8	1/2	12.7	1-1/2	38.1

COMBINATION FLUSH & 7° BEVEL TRIMMING BIT

Provides 7° bevel or 0° square cut on the edge of plastic laminated surfaces.

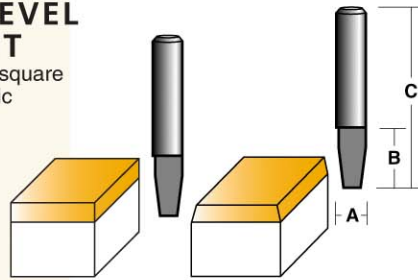

SOLID CARBIDE - SINGLE FLUTE
6.35 mm (1/4") SHANK

PART No.	A		B		C	
	in.	mm	in.	mm	in.	mm
T 2614	1/4	6.35	3/8	9.5	1-1/2	38.1

COMBINATION FLUSH & 22° BEVEL TRIMMING BITS

Provides 22° bevel or 0° square cut on the edge of plastic laminated surfaces.

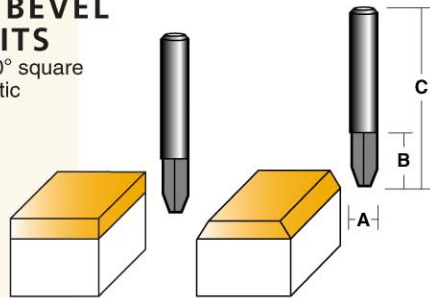

SOLID CARBIDE - SINGLE FLUTE
6.35 mm (1/4") SHANK

PART No.	A		B		C	
	in.	mm	in.	mm	in.	mm
TBD 22	1/4	6.35	1/2	12.7	1	25.4
TBDX 22	1/4	6.35	1/2	12.7	1-1/2	38.1

FLUSH TRIMMING BIT

Makes square trim edge cuts. Has integral pilot

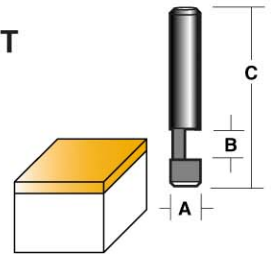

SOLID CARBIDE - SINGLE FLUTE WITH PILOT
6.35 mm (1/4") SHANK

PART No.	A		B		C	
	in.	mm	in.	mm	in.	mm
T 303-500	1/4	6.35	1/4	6.35	1-1/2	38.1

COMBINATION FLUSH & 22° BEVEL TRIMMING BITS

Provides a 22° or 0° straight cut on the edge of plastic laminated surfaces.

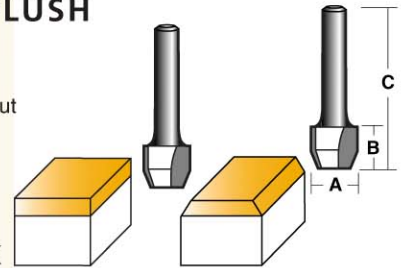

CARBIDE TIPPED - TWO FLUTES
6.35 mm (1/4") SHANK

PART No.	A		B		C	
	in.	mm	in.	mm	in.	mm
T 2622	15/32	12	7/16	11	1-5/8	41
TX 2622	9/16	14.3	3/4	19	-	51

30° BEVEL TRIMMING BITS

Provides a 30° bevel to trim the edge of plastic laminated surfaces.

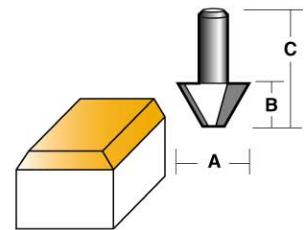

CARBIDE TIPPED - TWO FLUTES
6.35 mm (1/4") SHANK

PART No.	A		B		C	
	in.	mm	in.	mm	in.	mm
TBD 30	5/8	15.9	3/8	9.5	1	25.4
TBDX 30	5/8	15.9	3/8	9.5	1-3/8	35

EDGE BAND TRIM BITS

CARBIDE TIPPED

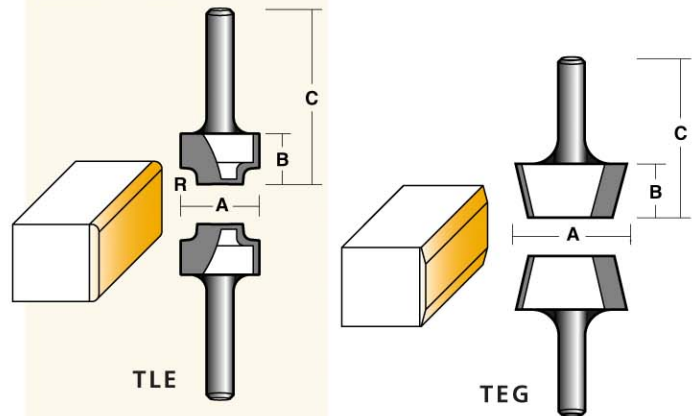

PART No.	A		B		C		R RADIUS	
	in.	mm	in.	mm	in.	mm	in.	mm
TLE 24	3/4	19.0	31/64	12.3	1-45/64	43.3	5/64	2.0
TLE 24 LH	3/4	19.0	31/64	12.3	1-45/64	43.3	5/64	2.0

15° BEVEL

PART No.	A		B		C	
	in.	mm	in.	mm	in.	mm
TEG 15	1-17/64	32.0	33/64	13.0	1-1/2	38.1
TEG 15 LH	1-17/64	32.0	33/64	13.0	1-1/2	38.1

